

卫生级清洗设备 Sanitary Cleaning Equipment

卫生级清洗设备 Sanitary Cleaning Equipment



应用：

清洗设备系列产品主要应用在食品加工，饮料，啤酒制药工业领域等罐设备上，对罐内部进行喷射和清洗。

清洗分为三个系列产品。

固定清洗球：360度全部喷射，180度喷射，喷射孔径2.5mm

旋转清洗球：球状为椭圆形和圆形，可进行全方位清洗。

旋转清洗器：多位喷射式，工作时喷射口全部旋转喷射

Applications:

Cleaning equipment products are mainly used to clean inside of the tank in food-processing, beverage, beer, pharmaceutical industries.

Cleaning equipment has 3 series:

Fixed cleaning ball: 360 degree spray completely, 180 degree spray, hole of spray is 2.5mm

Rotary cleaning ball: ball is spherical and elliptical. It can make all-round cleaning

Rotary cleaner: multi-position spray type. The spray will do rotate spary when it work.

技术参数：

材质：304/316L

最高工作温度：95℃

最高外界温度：150℃

Technical Details:

Material : 304/316L

Max. working temperature : 95℃

Max. ambient temperature: 150 °C

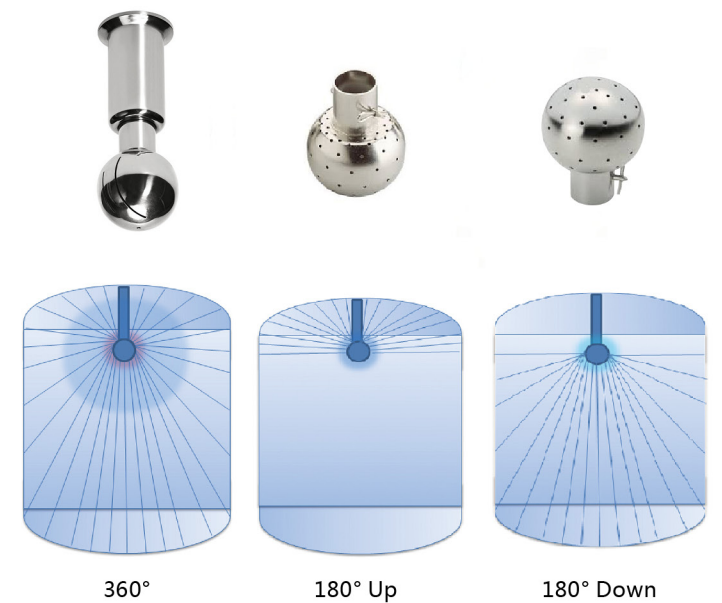

螺纹式固定清洗球
Threaded Fixed Cleaning Ball

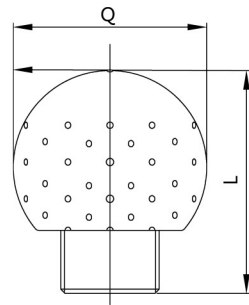

SIZE	L	Q
DN25	1"	72
DN32	1.25"	85
DN40	1.5"	87
DN50	2"	102

技术参数
Technical Details

SIZE	工作压力 Working Pressure (bar)	清洗直径 Cleaning radius(m)	流量 360°/180° Flow rate m ³ /h
DN25	1"	2.5	1~1.25
DN32-DN40	1.25"~1.5"	2.5	1.25~1.75
DN50	2"	3.5	2~3
DN65	2.5"	3.5	3~3.5

插销式固定清洗球
Bolted Fixed Cleaning Ball

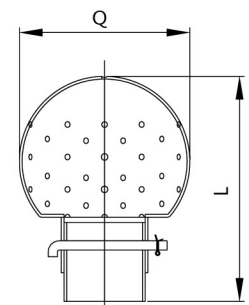

SIZE	L	Q
DN25	1"	95
DN40	1.5"	110
DN50	2"	125
DN65	2.5"	135

技术参数
Technical Details

SIZE	工作压力 Working Pressure(bar)	清洗直径 Cleaning radius(m)	流量 360°/180° Flow rate m ³ /h
DN25	1"	2.5	1~1.25
DN32-DN40	1.25"~1.5"	2.5	1.25~1.75
DN50	2"	3.5	2~3
DN65	2.5"	3.5	3~3.5

卡箍式固定清洗球
Clamp Fixed Cleaning Ball

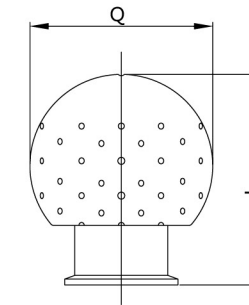

SIZE	L	Q
DN25	1"	80
DN32	1.25"	93
DN40	1.5"	93
DN50	2"	108
DN65	2.5"	115

技术参数
Technical Details

SIZE	工作压力 Working Pressure(bar)	清洗直径 Cleaning radius(m)	流量 360°/180° Flow rate m ³ /h
DN25	1"	2.5	1~1.25
DN32-DN40	1.25"~1.5"	2.5	1.25~1.75
DN50	2"	3.5	2~3
DN65	2.5"	3.5	3~3.5

焊接式固定清洗球
Welded Fixed Cleaning Ball

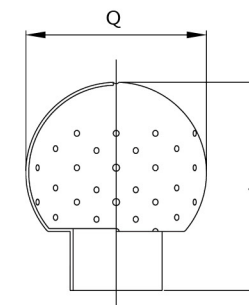

SIZE	L	Q
DN25	1"	72
DN40	1.5"	85
DN50	2"	87
DN65	2.5"	102

技术参数
Technical Details

SIZE	工作压力 Working Pressure(bar)	清洗直径 Cleaning radius(m)	流量 (360°/180°) Flow rate m ³ /h
DN25	1"	2.5	1~1.25
DN32-DN40	1.25"~1.5"	2.5	1.25~1.75
DN50	2"	3.5	2~3
DN65	2.5"	3.5	3~3.5

螺纹式旋转清洗球
Threaded Rotary Cleaning Ball

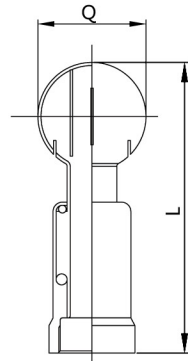

SIZE	L	Q
DN25 1"	140	45/53
DN32 1.25"	160	53/63
DN40 1.5"	170	53/63
DN50 2"	192	63/76
DN65 2.5"	220	76/91

技术参数
Technical Details

SIZE	工作压力 Working Pressure(bar)	清洗直径 Cleaning radius(m)	流量 Flow rate m ³ /h
DN25-DN40 1"~1.5"	2	1.25	12
DN50 2"	2	1.5	38
DN65 2.5"	2	2	38

插销式旋转清洗球
Bolted Rotary Cleaning Ball

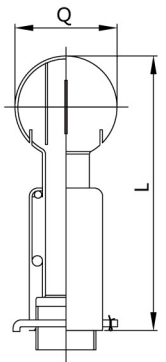

SIZE	L	Q
DN25 1"	135	45/53
DN32 1.25"	137	53/63
DN40 1.5"	137	53/63
DN50 2"	168	63/76
DN65 2.5"	190	76/91

技术参数
Technical Details

SIZE	工作压力 Working Pressure(bar)	清洗直径 Cleaning radius(m)	流量 Flow rate m ³ /h
DN25-DN40 1"~1.5"	2	1.25	12
DN50 2"	2	1.5	38
DN65 2.5"	2	2	38

卡箍式旋转清洗球
Clamped Rotary Cleaning Ball

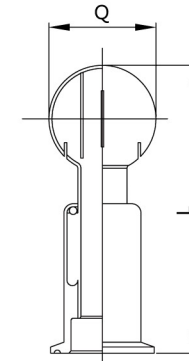

SIZE	L	Q
DN25 1"	138	45/53
DN32 1.25"	138	53/63
DN40 1.5"	138	53/63
DN50 2"	168	63/76
DN65 2.5"	190	76/91

技术参数
Technical Details

SIZE	工作压力 Working Pressure(bar)	清洗直径 Cleaning radius(m)	流量 Flow rate m ³ /h
DN25-DN40 1"~1.5"	2	1.25	12
DN50 2"	2	1.5	38
DN65 2.5"	2	2	38

焊接式旋转清洗球
Welded Rotary Cleaning Ball

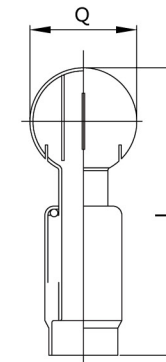

SIZE	L	Q
DN25 1"	143	45/53
DN32 1.25"	145	53/63
DN40 1.5"	145	53/63
DN50 2"	180	63/76
DN65 2.5"	200	76/91

技术参数
Technical Details

SIZE	工作压力 Working Pressure(bar)	清洗直径 Cleaning radius(m)	流量 Flow rate m ³ /h
DN25-DN40 1"~1.5"	2	1.25	12
DN50 2"	2	1.5	38
DN65 2.5"	2	2	38

卫生级清洗设备

Sanitary Cleaning Equipment

螺纹式旋转清洗球
Threaded Rotary Cleaner

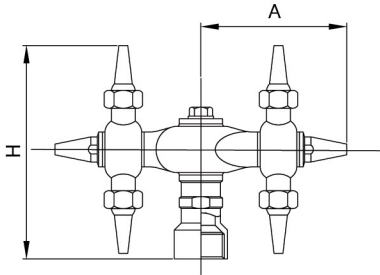

SIZE	A	H	工作压力 Working Pressure(bar)	清洗直径 Cleaning radius(m)	流量 Flow rate m ³ /h
DN25	1"	118	1.5~0	2~3	23
DN40	1.5"	142	1.8~2.5	2.5~3	38
DN50	2"	145	2.5~3	3.5~4	60

插销式旋转清洗球
Bolted Rotary Cleaner

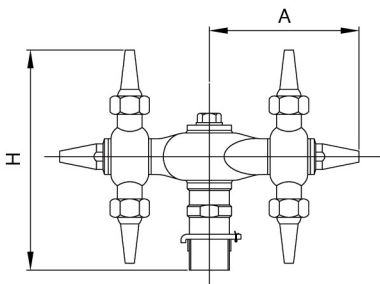

SIZE	A	H	工作压力 Working Pressure(bar)	清洗直径 Cleaning radius(m)	流量 Flow rate m ³ /h
DN25	1"	118	1.5~2	2~3	23
DN40	1.5"	142	1.8~2.5	2.5~3	38
DN50	2"	145	2.5~3	3.5~4	60