

卫生级人孔 *Sanitary Manhole Cover*



卫生级人孔 Sanitary Manhole Cover

应用：

人孔主要应用在食品，酒类，饮料，制药等工业领域的储罐设备上。以便对设备内部进行维护。

Application:

Manhole is mainly used in food, wine, beverage, pharmaceutical and other industrial storage tank equipment. In order to maintain the internal equipment

技术参数：

密封材质：硅胶，三元乙丙，丁腈，氟橡胶符合 FDA177.2600;
 材质：304(1.4301), 316L(1.4404)
 内表面处理：0.4μm-0.8μm
 外表面处理：镜面抛光，亚光，喷砂处理。

Technical Details:

Gasket: Silicone/EPDM/NBR/FPM in accordance with FDA 177.2600.
 Material: 304(1.4301), 316L(1.4404)
 Internal surface: 0.4μm-0.8μm
 Outside surface: Mirror polished, Matte, sand-blasting finished.



卫生级人孔 Sanitary Manhole Cover

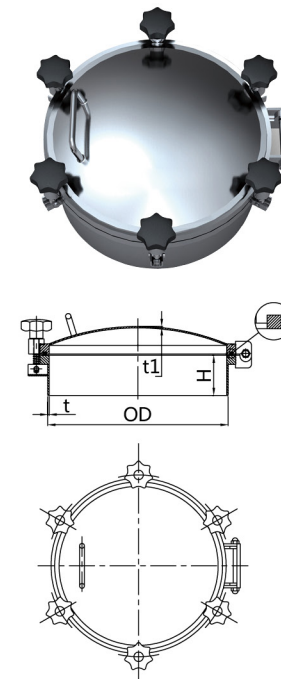

圆型压力人孔
Round Outward Pressure Manway

SIZE	OD (mm)	t (mm)	H (mm)	t1 (mm)	手轮数量 Handwheel-Num	压力 P (Bar)
200	206	3	100	3	4	1 - 3
300	306	3	100	3	4	1 - 3
350	356	3	100	3	5	1 - 3
400	406	3	100	3	6	1 - 3
430	436	3	100	3	6	1 - 3
450	456	3	100	3	6	1 - 3
500	508	4	100	3	6	1 - 3
600	608	4	100	4	6	1 - 3

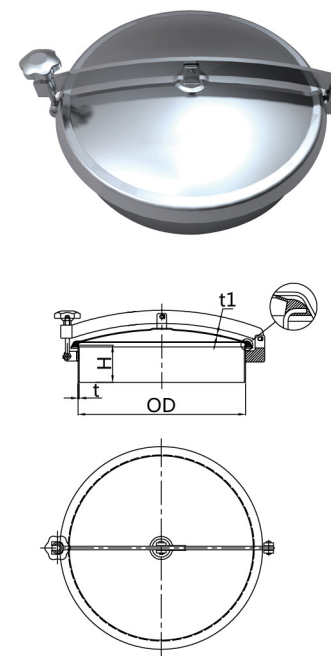

圆型常压人孔
Round Outward Manway

SIZE	OD (mm)	t (mm)	H (mm)	t1 (mm)	压力 P (Bar)
200	200	2.5	100	2	0 - 0.1
219	219	2.5	100	2	0 - 0.1
300	300	2.5	100	2	0 - 0.1
350	350	2.5	100	2	0 - 0.1
400	400	3	100	2.5	0 - 0.1
430	430	3	100	2.5	0 - 0.1
450	450	3	100	2.5	0 - 0.1
500	500	3	100	2.5	0 - 0.1
600	600	4	100	3	0 - 0.1
420×300 (Oval- 椭圆)	420×300	3	100	2.5	0 - 0.1

高度 (H) 和颈圈 (t) 及盖子 (t1), 可根据您的需求定制。
 Height(H) and Frame (t) and cover (t1) can be customized according to your requirement.

卫生级人孔 Sanitary Manhole Cover

卫生级人孔 Sanitary Manhole Cover



圆型常压人孔 (上部密封)
Round Outward Manway (Upper Seal)

SIZE	OD (mm)	t (mm)	H (mm)	t1 (mm)	压力 P (Bar)
300	304	2	100	1.5	0 - 1
350	354	2	100	1.5	0 - 1
430	434	2	100	1.5	0 - 1
450	454	2	100	1.5	0 - 1
500	504	2	100	1.5	0 - 1

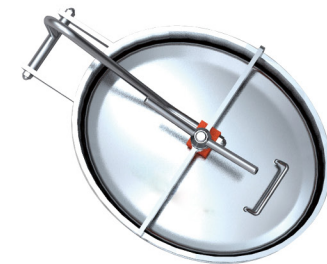
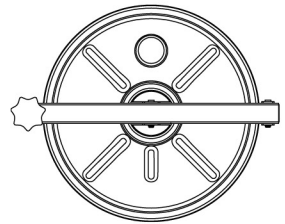
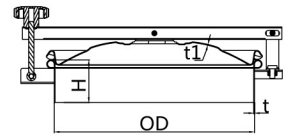

内开式椭圆人孔
Oval Inward Manway

SIZE	OD(mm) L1 × L2	t (mm)	H (mm)	t1 (mm)	压力 P (Bar)
430 × 330	430 × 330	8	75	2.5	1 - 3
435 × 335	435 × 335	10	75	2.5	1 - 3
450 × 350	450 × 350	8	75	3	1 - 3
530 × 430	530 × 430	10	75	3	1 - 3
535 × 435	535 × 435	12	75	3	1 - 3
635 × 525	635 × 525	12	80	3	1 - 3

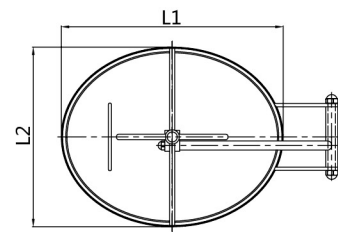
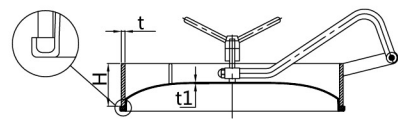

高度 (H) 和颈圈 (t) 及盖子 (t1), 可根据您的需求定制。
Height(H) and Frame (t) and cover (t1) can be customized according to your requirement.



内开式带斜边椭圆人孔
Oval Inward Manway with Bevel Edge

SIZE	OD(mm) L1 × L2	t (mm)	H (mm)	t1 (mm)	压力 P (Bar)
550 × 450 A	550 × 450	3	80	4	1 - 3
550 × 450 B	550 × 450	4	80	5	1 - 3
565 × 465	565 × 465	4	100	5	1 - 3
580 × 480	580 × 480	4	133	5	1 - 3

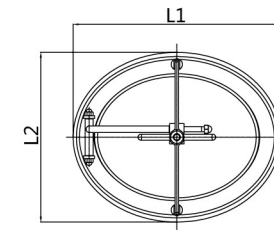
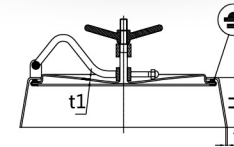

圆形带视镜压力人孔
Round Outward Manway With Sight Glass

SIZE	OD (mm)	t (mm)	H (mm)	t1 (mm)	视镜 Sight Glass	压力 P (Bar)
200	206	3	100	3	DN80	1 - 3
300	306	3	100	3	DN80	1 - 3
350	356	3	100	3	DN80	1 - 3
400	406	3	100	3	DN80	1 - 3
430	436	3	100	3	DN80	1 - 3
450	456	3	100	3	DN80	1 - 3
500	508	4	100	3	DN100	1 - 3
600	608	4	100	4	DN100	1 - 3

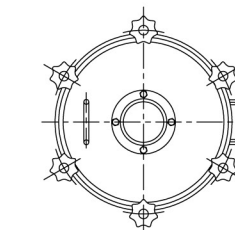
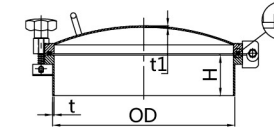

高度 (H) 和颈圈 (t) 及盖子 (t1), 可根据您的需求定制。
Height(H) and Frame (t) and cover (t1) can be customized according to your requirement.

卫生级人孔 Sanitary Manhole Cover



双锁方型人孔
Rectangular Manway With Two Intersectant Arms

SIZE	OD(mm) L1 × L2	t (mm)	H (mm)	t1 (mm)	压力 P (Bar)
235 × 185	235 × 185	5	70	1.5	1 - 3
435 × 335	435 × 335	8	80	3	1 - 3
535 × 435	535 × 435	8	100	3	1 - 3
700 × 500	700 × 500	12	100	3	1 - 3

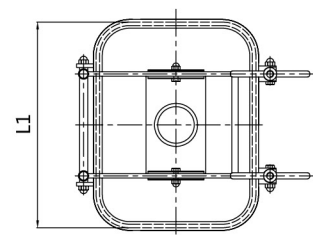
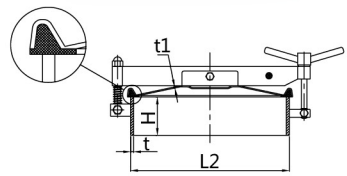

单锁方型人孔
Rectangular Manway With One Intersectant Arms

SIZE	OD(mm) L1 × L2	t (mm)	H (mm)	t1 (mm)	压力 P (Bar)
235 × 185	235 × 185	5	70	1.5	1 - 3
435 × 335	435 × 335	8	80	3	1 - 3
535 × 435	535 × 435	8	100	3	1 - 3
700 × 500	700 × 500	12	100	3	1 - 3

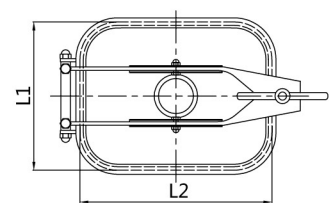
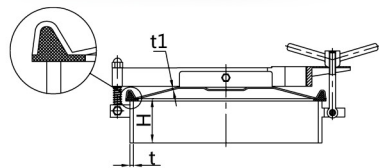

高度 (H) 和颈圈 (t) 及盖子 (t1), 可根据您的需求定制。
Height(H) and Frame (t) and cover (t1) can be customized according to your requirement.

卫生级人孔 Sanitary Manhole Cover

SIZE: DN600



圆型常压糖化人孔
Round Manway With Sight Glass

SIZE	OD (mm)	t (mm)	H (mm)	t1 (mm)	视镜 Sight Glass	压力 P (Bar)
350	355	2.5	100	2.5	DN80	0-0.2
400	406	3	100	3	DN100	0-0.2
450	456	3	100	3	DN150	0-0.2
500	506	3	100	3	DN200	0-0.2
600	608	4	100	3	DN400/500	0-0.2

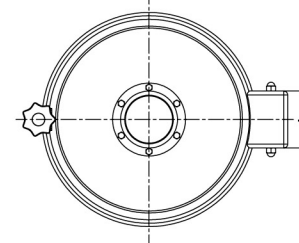
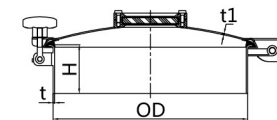
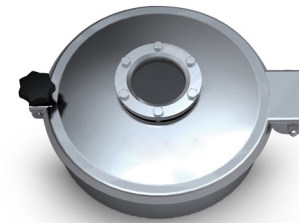

高度 (H) 和颈圈 (t) 及盖子 (t1), 可根据您的需求定制。
Height(H) and Frame (t) and cover (t1) can be customized according to your requirement.